

Characterising Roof Ventilators

A. Revel¹ and B.P. Huynh²

¹Ex-Faculty of Engineering, UTS, P.O. Box 123, Broadway 2007, AUSTRALIA

²Faculty of Engineering, UTS, P.O. Box 123, Broadway 2007, AUSTRALIA

Abstract

Extraction performances of roof-mounted ventilators are compared using data from tests based on an Australian/New Zealand Standard. The results show that a single performance curve (embodying air extraction rates, wind speeds, throat size and pressure differentials across the devices) characterises each ventilator. This also shows that the constant parameters specified in the current Standard are far too simplistic to adequately describe a device's performance.

List of Symbols

Δp = pressure difference across ventilator as per figure 1 (Pa)

Δp_v = close-range pressure drop across ventilator (Pa)

V = wind speed acting on ventilator (m/s)

Q = measured flow rate through ventilator (m³/s)

A_t = ventilator geometric throat area (m²)

v = air speed through ventilator throat, calculated as $v = Q/A_t$ (m/s)

ρ = air density (1.2 kg/m³)

Introduction

Efforts to clear smoke, foul air and damp from dwellings, ships and factories have produced various designs of ventilators, sometimes fitted to assist draft through chimneys but more often mounted on roofs. Wind influenced roof ventilators (also called eductors) such as cowls, swivelling elbows, venturi and turbine types compete with powered fans to clear spaces of vapours and foul air. These ventilators also allow hot gases to escape, as well as exclude rain and vermin. Very few published works on these devices can be found. In 1932 O. Savonius [3] and O. Back [2] published test results comparing cowls and the S-rotor wind-driven fan invented by S. V. Savonius. Back mentions earlier work by Professor Rietschel in Germany (1906 and 1910) and in France ("Concourse d' Aspirateurs de Fumes", 1929). The last two tested only with "free suction" or ambient upstream pressure. Savonius and Back tested over a range of "suction pressures". Their methods were similar – a free jet blowing over an eductor which withdrew air from a "suction box" or plenum. Those tests were done at plenum pressures less than or equal to ambient. Back used a "Prandtl tube", set in the Φ 160 mm x 6 m inlet duct, and micromanometer to measure duct air velocities. Savonius used a cup anemometer in the inlet duct. Apart from these very early works there has been virtually nothing else published since then that the authors are aware of, particularly in English.

Australian/New Zealand Standard, AS/NZS 4740:2000. An industry has been developing around natural ventilation for over a century. Prior to 2000 there was no Australian Standard for natural ventilators. The first such Standard, AS/NZS 4740, was published in March 2000 [1]. It covers classification and testing for wind loading, rain penetration, flow and pressure drop. Louvres and grilles are classified as type 1 and serve as either air inlets or outlets on buildings. Types 2, 3 and 4 withdraw air by the influence of wind (eductors):

- type 2 being static (cowl, ridge, louvred cupola, etc.),

- type 3 being wind directional (swivelling elbow or hood),

- type 4 being turbine type.

This Standard [1] has essentially been an arbiter laying down test procedures and defining the following for ventilators:

- discharge coefficient C_i at a particular wind speed,

$$C_i = (Q/A_t) \times \sqrt{\rho/2\Delta p_v} \quad (1)$$

which then gives the mean discharge coefficient C_{mean} for a number n of wind speeds, and the ventilator's discharge coefficient C_d as

$$C_{\text{mean}} = \sum_{i=1}^n \frac{C_i}{n}, \text{ and } C_d = C_{\text{mean}} - \text{errors} \quad (2)$$

- flow coefficient for a particular wind speed,

$$(C_f)_i = \frac{v}{V} \quad (3)$$

A ventilator's flow coefficient C_f is then the average of a number of such $(C_f)_i$.

Results from equations 2 and 3 are then used to estimate extraction by "wind siphonage". So, in effect, C_d and C_f are the two parameters used to quantify a ventilator's air extraction performance.

Client and Industry. It was through a request from the Australian Consumers' Association that this work was started. For the ventilation industry, interest is in extraction rate Q , wind speed V , and pressure difference Δp - from the space being vented, across the ventilator, to the outside ambient. The request was for a concise and consistent way to assess the ventilators quantitatively, and for the test results to be shown in a manner that will distinguish them.

Responding to this request, experiments have been set up and a variety of these devices tested. Two ways of presenting results will be shown here; neither is mentioned in the current Standard [1]. In particular, it will be seen that a single non-dimensional curve captures succinctly a ventilator's performance, and thus presents a better method of characterizing such a device than the simple, constant parameters specified in the current Standard. In this work, attention is given to type 4; but other simple ventilators are also shown for comparison.

Experiments

Apparatus. The experimental set-up follows recommendation in the Standard [1], and is shown in figure 1. In the first set up (figure 1(a)), ventilators were fixed on top of a rectangular box or plenum. A variable speed 800 mm diameter axial fan produced the "wind" on the ventilator. Air was supplied to the plenum by a radial fan via a metering nozzle. By changing the supply fan's speed, plenum pressure (Δp) was varied from a negative to a positive value with respect to ambient. Having a supply fan to overcome duct losses is a practice used in fan testing. Here it was used to provide a wide range of plenum pressures.

As testing proceeded, wind speeds and plenum pressures increased. So did supply air requirements. To achieve required

flow rates, the radial fan's speed (figure 1(a)) was increased until the fan disintegrated. At this stage it was realised that flow rates beyond 6000 litres per minute ($0.1 \text{ m}^3/\text{sec}$) may be required. Such flow rates could be met by a 400 mm axial fan and duct (figure 1(b)). Fan surge had to be watched as the supply flow can become unsteady and the manometers erratic.

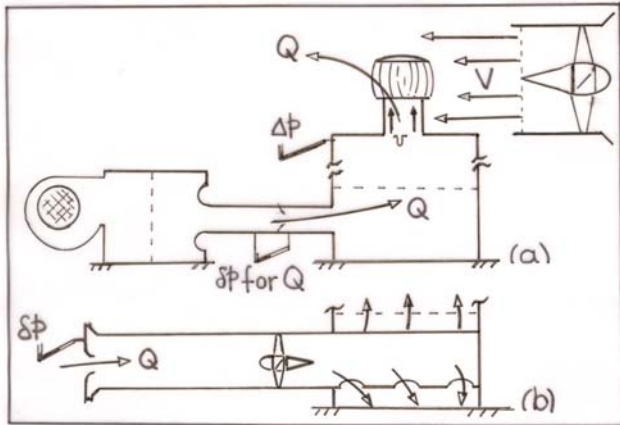

Figure 1: Schematic of eductor test rigs comprising: large wind producing fan, plenum, variable speed supply fan, flow metering and sensitive manometers (0 to 125 Pa).

- (a) original test rig using radial fan, Φ 100 mm x 4 m duct with Φ 65 mm metering nozzle,
 - (b) Φ 400 axial fan and duct replacement for radial fan.
- In both cases the plenum was 1.2 m square x 2.4 m high.

Method. The Standard [1] specifies five “minimum required incident air velocities” from 0.72 m/s to 3.6 m/s (2.6 to 12.96 km/hr). Sydney’s average wind speed is taken as 12 km/hr hence natural ventilation calculations for extraction are based on a wind speed of 12 km/hr for Sydney. Greater test wind speeds are recommended in case of unusual behaviour beyond 13 km/hr.

By performing calibration runs before each series of tests relationships between fan speed and wind speed are established. This is done with an anemometer placed at the position where the eductor will later be located. A linear relationship between wind speed and fan speed has been obtained, as may be expected, since fan discharge is proportional to fan speed. This allows setting a wind speed without the presence of an anemometer while testing.

Wind uniformity. It is prudent to assess wind uniformity. For this a Pitot rake was used to determine a number of velocity profiles across the jet. From these, average wind speeds were estimated. Variation of wind speed was considered acceptable if it was within 2.5% about the average value.

Four devices. Four ventilating devices, shown in figure 2, were tested. Turbine eductors are shown in figures 2(a) and (b). Figure 2(c) shows a Φ 300 mm throat omni-directional venturi formed from two spherical segments spaced 150 mm apart; and figure 2(d) a Φ 300 mm x 300 mm high open stub.

Results and Discussion

Test results were first plotted as a series of curves of plenum pressures Δp against flow rates Q at different wind speeds, rather analogous to fan characteristics; see figures 3(a) to 6(a). This representation does not readily compare eductors; overlaying so many curves became confusing. Following Back and Savonius [2, 3], the measurements are also plotted using the non-dimensional parameters v/V and $\Delta p/(\frac{1}{2}\rho V^2)$. These are shown in figures 3(b) to 6(b). The data collapse very well into single curves, each embodying air extraction rates, wind speeds, throat

size and pressure differentials. Note that in these figures, Δp is as shown in figure 1. Thus Δp is the difference between pressure in the plenum just before the ventilator’s inlet, and that of the ambient.

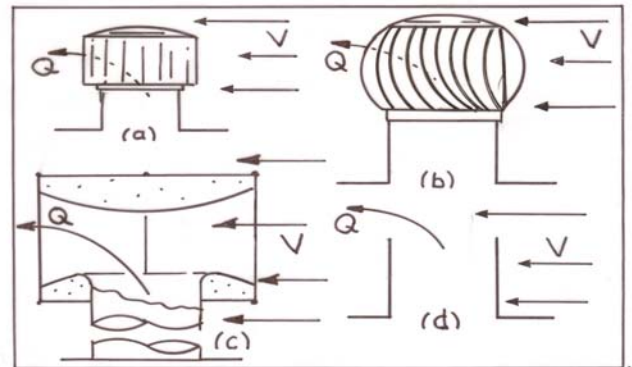

Figure 2: Diagram of the four ventilating devices (eductors) tested;

- (a) 250 mm throat turbine type,
- (b) 300 mm throat turbine type,
- (c) 300 mm throat omni directional venturi,
- (d) 300 mm bore open stub.

On the other hand, it can also be seen from the present measurements that the two parameters C_d and C_f recommended in the Standard as bases for quantifying a ventilator’s performance are far too simplistic for the purpose.

For example, using data of figure 5(a), and taking the pressure immediately behind the device (in the direction of air extraction) as equal to the plenum pressure at zero flow rate, the following has been obtained:

With 18 km/hr wind, plenum pressure is -6.7 Pa at $Q = 0 \text{ l/min}$, and -4 Pa at $Q = 2000 \text{ l/min}$. Thus $\Delta p_v = -4 - (-6.7) = 2.7 \text{ Pa}$. Equation (1) then gives $C_i = k \times 2000 / \sqrt{2.7} = 1220 \times k$, where k is a constant incorporating the conversion factors, throat area and air density. Similarly, with 8 km/hr wind, the corresponding figures are -1 Pa at $Q = 0 \text{ l/min}$, 2 Pa at $Q = 5000 \text{ l/min}$. Equation (1) then gives $C_i = k \times 5000 / \sqrt{3} = 2890 \times k$. Clearly, such a wide variation of C_i values would make C_d , which is based on the average of these values as per equation (2), too simplistic and thus unsuitable as a representative characteristic of a ventilator.

The flow coefficient (C_f) can similarly be seen to vary so widely that its average C_f would be unsuitable as a parameter characterizing a ventilator. This is clearly illustrated in all non-dimensional plots.

Now that individual ventilator’s characteristic can be succinctly described by a single curve, relative performances of the four devices tested can be concisely shown. This is done in figure 7. Clearly the open stub withdraws best. In reality, this device is impractical as a roof ventilator, because it had neither vermin mesh nor a “conical top” to exclude rain. It can however stand as a base-line model for eductors. Similarly impractical is the omni directional venturi which had no surrounding mesh to prevent birds nesting. The only practical eductors here are the turbine types shown in figure 2(a) and (b).

Conclusions

Measurements of air extraction characteristics of 4 wind-influenced ventilators have been presented. The non-dimensionalised data collapse well into single curves, which have been seen to be more suitable as performance indicators than the

simple parameters suggested in the current Standard on these devices. The ventilation industry would thus find these curves useful for specification purposes, and manufacturers for judging the effects of modification to their eductors or when developing new models. It has also been seen that as regards air extraction, the simple stub performs best.

Acknowledgements

- Chantal Buttini, Mech. Eng. UTS, student 1998,
- Emmanuel Christou, Mech. Eng. UTS, student 2004,
- CHOICE, Australian Consumers' Association,
- Tristan Day, School of Building UTS, Student 1997,
- Prof. J P Gostelow, Engineering, University of Leicester, U K,
- Kim Kennedy, Mech. Eng. UTS, student 2000,
- S. West, School of Architecture and Building UTS.

References

[1] Australian/New Zealand Standard AS/NZS 4740:2000, *Natural ventilators – Classification and performance*, Standards Australia, 2000

[2] Back, O., *Die Ermittlung der relativen Wertigkeit windbetätigter Saughauben*. Gesundheits-Ingenieur, Heft 51, 1932 (in German).

[3] Savonius, O., *Undersökning av Sughuvar och Rotor-Ventilatorer*, Sarryck ur Teknisk Tidskrift 1932, hafte 38. Mekanik 9 (in Finnish)

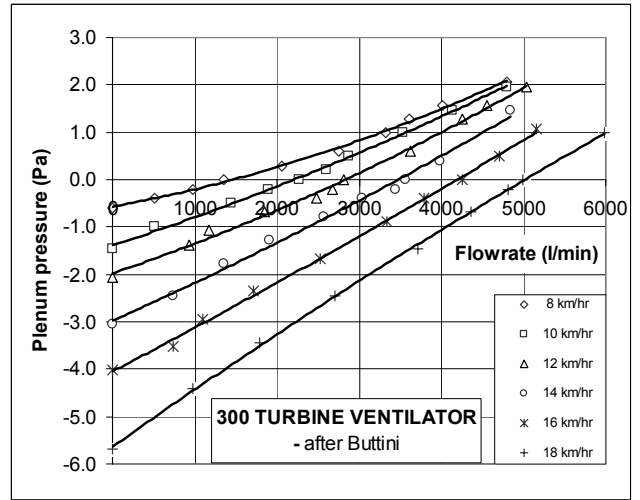

Figure 4(a): Results for 300 mm throat turbine ventilator - plots of plenum pressure (Δp) against extraction flow rate (Q) at set wind speeds.

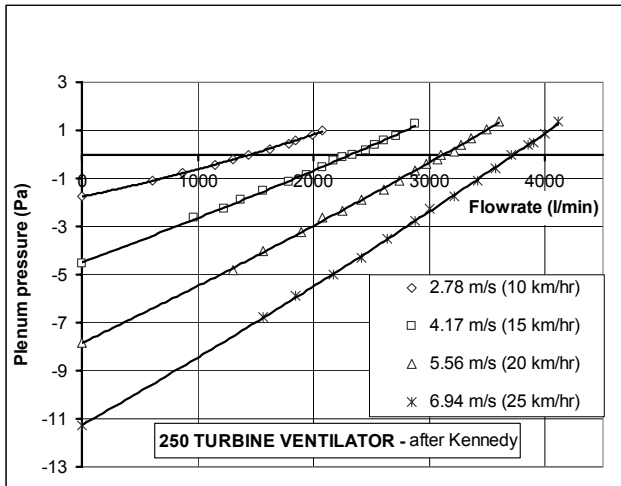

Figure 3(a): Results for 250 mm throat turbine ventilator - plots of plenum pressure (Δp) against extraction flow rate (Q) at set wind speeds.

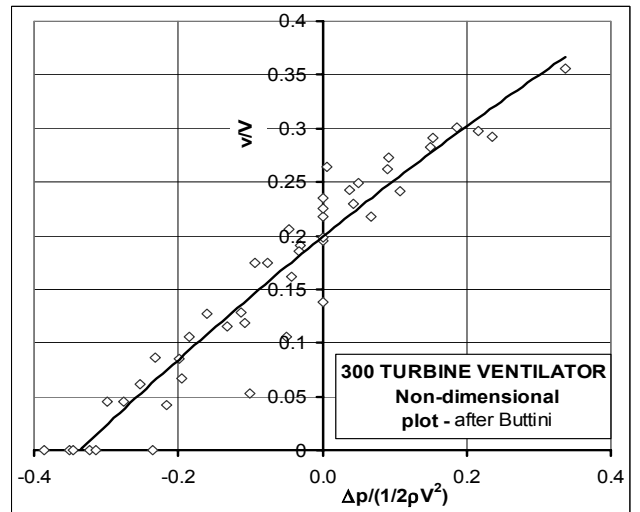

Figure 4(b): Results for 300mm throat turbine ventilator plotted non-dimensionally (from figure 4(a)).

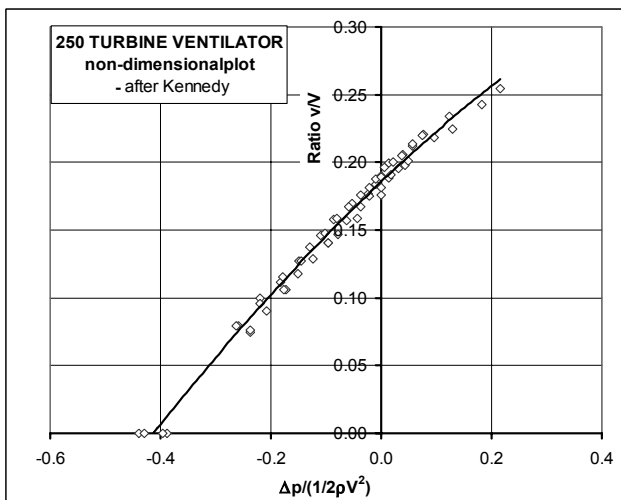

Figure 3(b): Results for 250 mm throat turbine ventilator plotted non-dimensionally (from figure 3(a)).

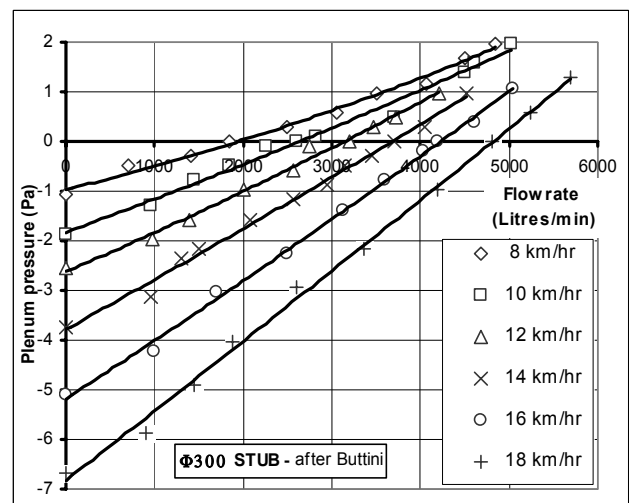

Figure 5(a): Results for $\Phi 300$ mm stub x 300 mm high. Each curve is a plot of plenum pressure (Δp) against flow rate (Q) at a set wind speed.

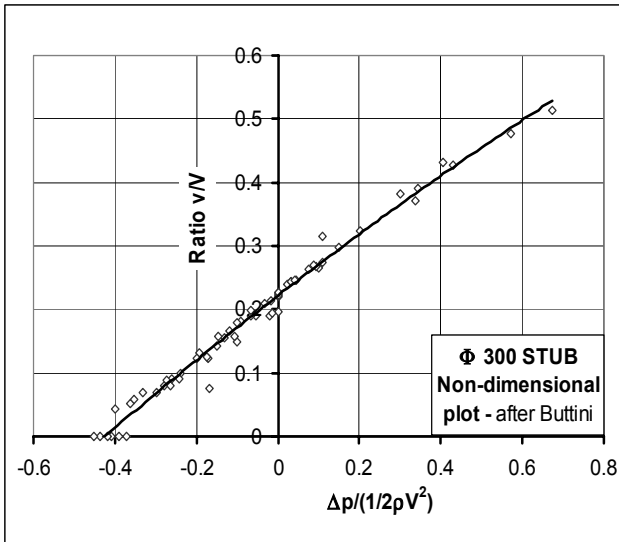

Figure 5(b): Results for Φ 300 mm stub plotted non-dimensionally (from figure 5(a)).

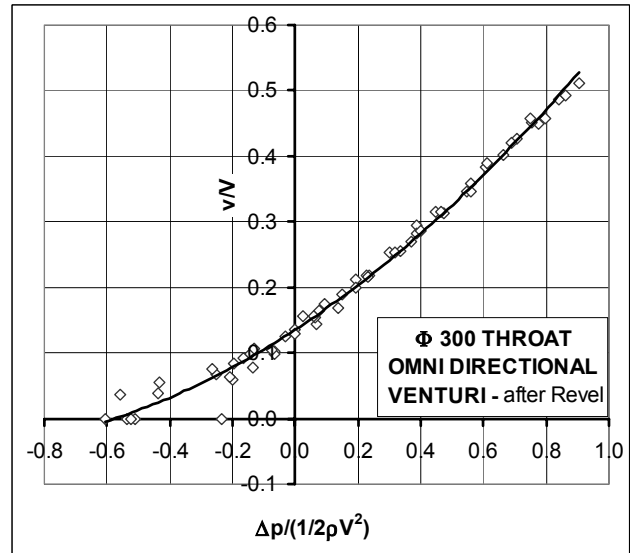

Figure 6(b): Results for Φ 300 omni directional venturi plotted non-dimensionally (from figure 6(a)).

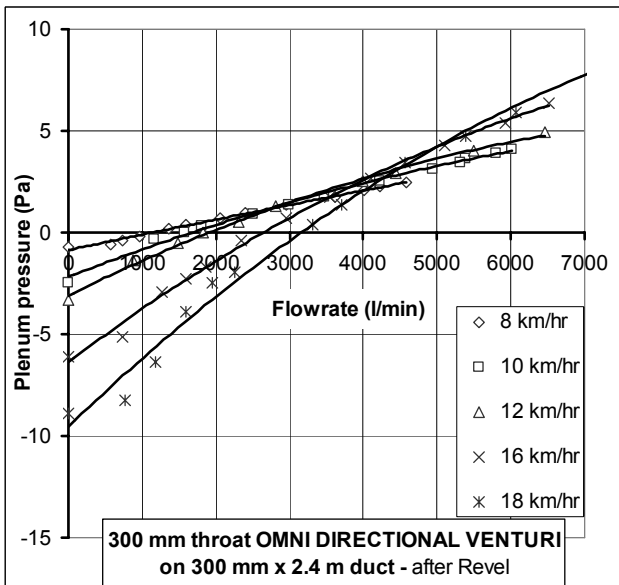

Figure 6(a): Results for Φ 300 omni directional venturi formed by spherical sectors (see figure 1) mounted onto a Φ 300 x 2400 mm high duct. – plenum pressure vs flow rate.

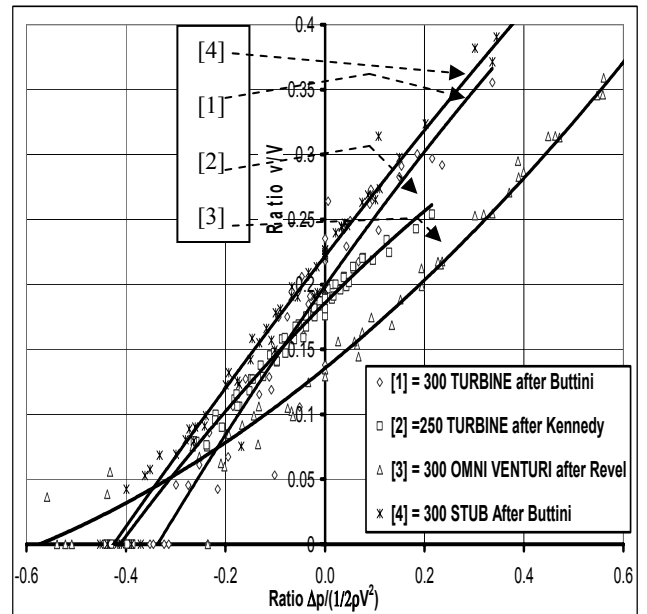

Figure 7: Combined non dimensional curves for the four eductors